

www.Blitzortung.org

A Time of Arrival Lightning Location Network¹

Egon Wanke, Düsseldorf, Germany

Email: blitzortung@gmx.org

November 4, 2008

1 Introduction

A lightning discharge emits radio frequency energy over a wide range of frequencies. When high currents occur in previously ionized channels during cloud-to-ground flashes, the most powerful emissions occur in the VLF range. VLF (very low frequency) refers to radio frequencies in the range of 3 kHz to 30 kHz. An essential advantage of low frequencies in contrast to higher frequencies is the property that these signals are propagated over thousands of kilometers by reflections from the ionosphere and the ground.

The lightning location network Blitzortung.org consists of several lightning receiver sites and one central processing server. The sites transmit their data in short time intervals over the Internet to the server. Every data sentence contains the precise time of arrival of the received lightning strike impulse ("sferic") and the exact geographic position of the site. With this information from all sites the exact positions of the discharges are computed. The sferic positions are made available in raw format to all sites that transmit their data to our server. The site owner can use the raw data for all non-commercial purposes. The lightning activity of the last two hours is additionally displayed on several public maps recomputed every minute.

Blitzortung.org is a community of site operators who transmit their data to the central server, programmers who develop and/or implement algorithms for the location or visualization of sferic positions, and people who assist anyway to keep the system running. There is no restriction on membership. All people who keep the network in operation are volunteers. There is no fee and no contract. If a site stops pooling its data, the server stops providing the access to the archive of sferics positions for that site.

The aim of the project is to accomplish a low budget lightning location network based on a high number of sites spaced close to each other, typically separated by 50 km - 250 km. The hardware you need to participate to the network consists of an orthogonal crossed VLF loop antenna, a VLF pre-amplifier, our evaluation board, a GPS receiver providing an 1PPS (one-pulse-per-second) signal, and a personal computer permanently connected to the Internet.

¹This document is still under development. If you have any comments to improve it, or if you find typos, please write a note to the author. It is not allowed to publish this document or excerpts of it on other websites than those of Blitzortung.org.

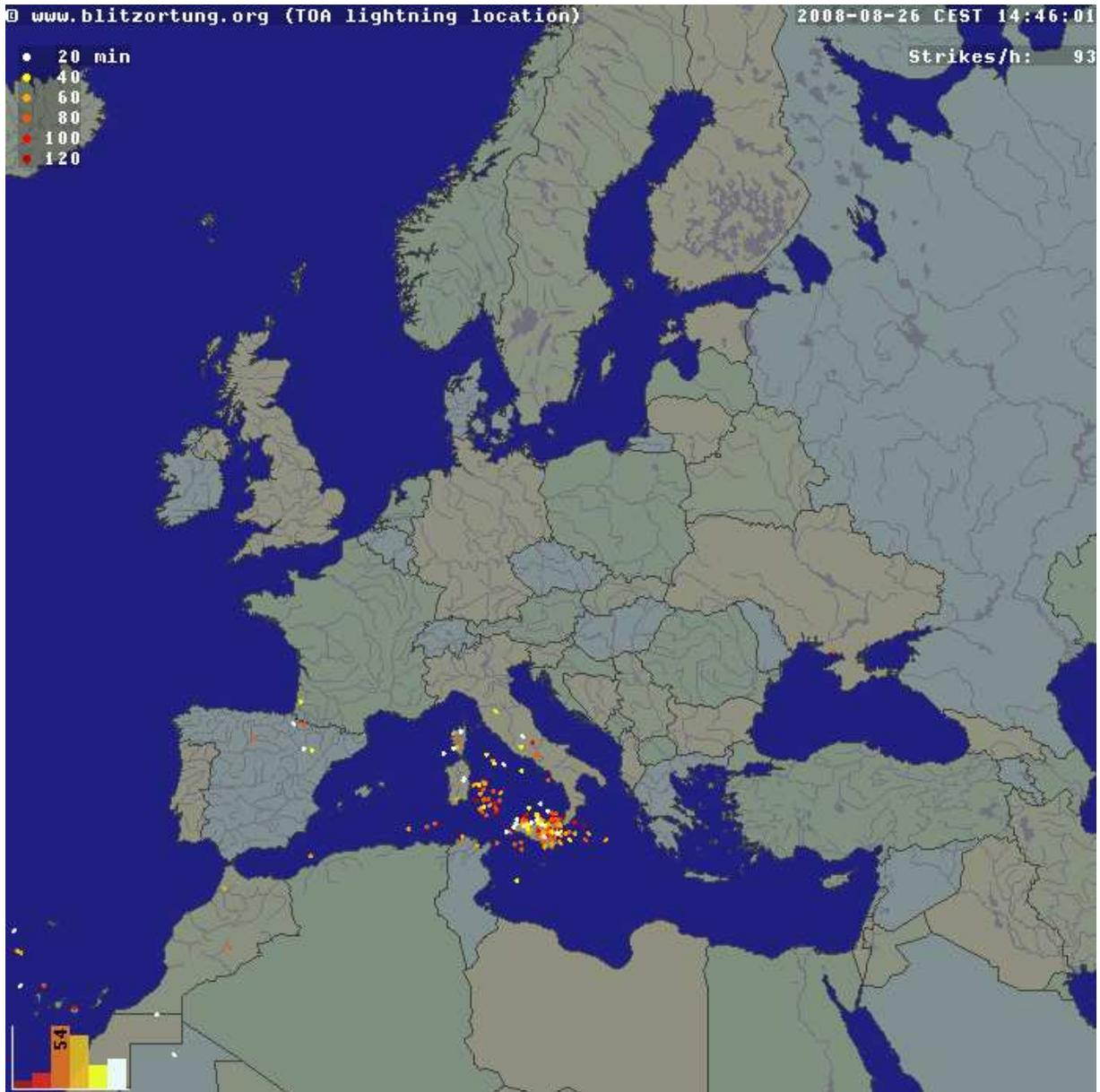

Figure 1: The lightning overview map of Europe at Blitzortung.org.

Note that every site only records the arrival times of lightning discharges. It is not possible to compute positions or at least directions with the data from one station. We need the data of several stations to compute strike positions. There is currently no software that enables you to set up a connection with other sites like the LR software of Frank Kooimann for the direction finding system. The computation of strike positions is currently only done by the central server. However, you are invited to contribute to the project by writing such software.

2 VLF antennas

Waves with a frequency between 30 and 3 kHz have a length between 10 and 100 km. An applicable antenna for these frequencies is a small loop antenna of size less than $1/10000$ of the wavelength in circumference. Small loops are also called magnetic loops, because they are more sensitive to the magnetic component of the electromagnetic wave, and less sensitive to near field electric noises when properly shielded. If the loop is small with respect to the wavelength, the current around the antenna is nearly completely in phase. Therefore, waves approaching in the plane of the loop will cancel, and waves in the axis perpendicular to the plane of the loop will be strongest. This property will change if the loop becomes larger.

The electromagnetic signals of lightning discharges are not waves of a fixed frequency. The signals have more or less the form of an impulse and thus emits waves over a wide range of frequencies. Every of these impulses is unique and looks different. To measure the time of arrival of a lightning discharge, we need a wide-band receiving system, and not a tuned system. The antenna should be very large to get a high voltage caused by the change of the electromagnetic field. On the other side, the resonance frequency should be as high as possible such that we can easily suppress these frequencies by a low-pass filter. You should strictly avoid to connect a tuning capacitor. Figure 2 shows a signal received by two equal sized loops antennas. Loop A has no tuning capacitor, the resonance frequency of the antenna is approximately 1000 kHz. The used pre-amplifier reduces frequencies of 1000 kHz by -72 dB. Loop A has a tuning capacitor of $1 \mu\text{F}$, the resonance frequency is approximately 10 kHz. Since lightning impulses often contain a lot of energy at 10 kHz, the tuned loop antenna only outputs uniform waves of 10 kHz.



Figure 2: A signal received by two equal sized loops. Loop A is tuned at 10 kHz.

The electric field of the radio waves emitted by cloud-to-ground lightning discharges is mostly oriented vertically, and thus the magnetic field is oriented horizontally. To cover

all directions (all-around 360 degree) it is advisable to use more than one loop. A suitable solution can be obtained by two orthogonal crossed loops as they are used for direction finding systems.

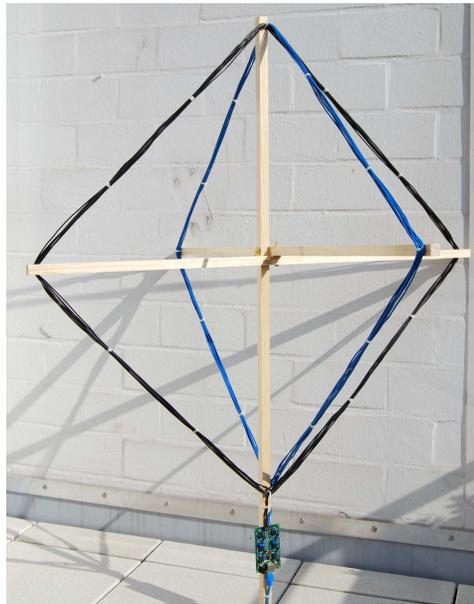

Figure 3: Two orthogonal crossed VLF loop antennas, 8 turns, diagonal size 1 m.

It is very easy to set up a loop antenna for VLF frequencies by yourself. A useful construction manual can be found, for example, at members.inode.at/576265. This document is written by Gerald Ihninger for the lightning radar project www.lightningradar.net.

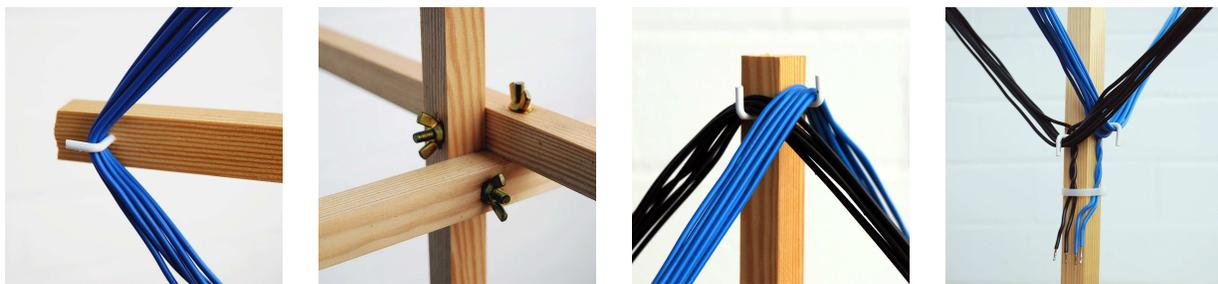

Figure 4: Assembling details of the loop antenna.

For a square loop antenna with a diagonal distance of 1 m and 8 turns of wire you need

- approximately 4 m of 20×20 mm wooden coving,
- 2×25 m cable with a single conductor of area 1.5 mm^2 (this corresponds to a diameter of 1.38 mm),
- 8 screw hooks,

- 3 screws/washer/wingnuts, and
- some cable ties.

The assembling takes about two hours. The price for the material is approximately 40 Euro in a German home improvement store.

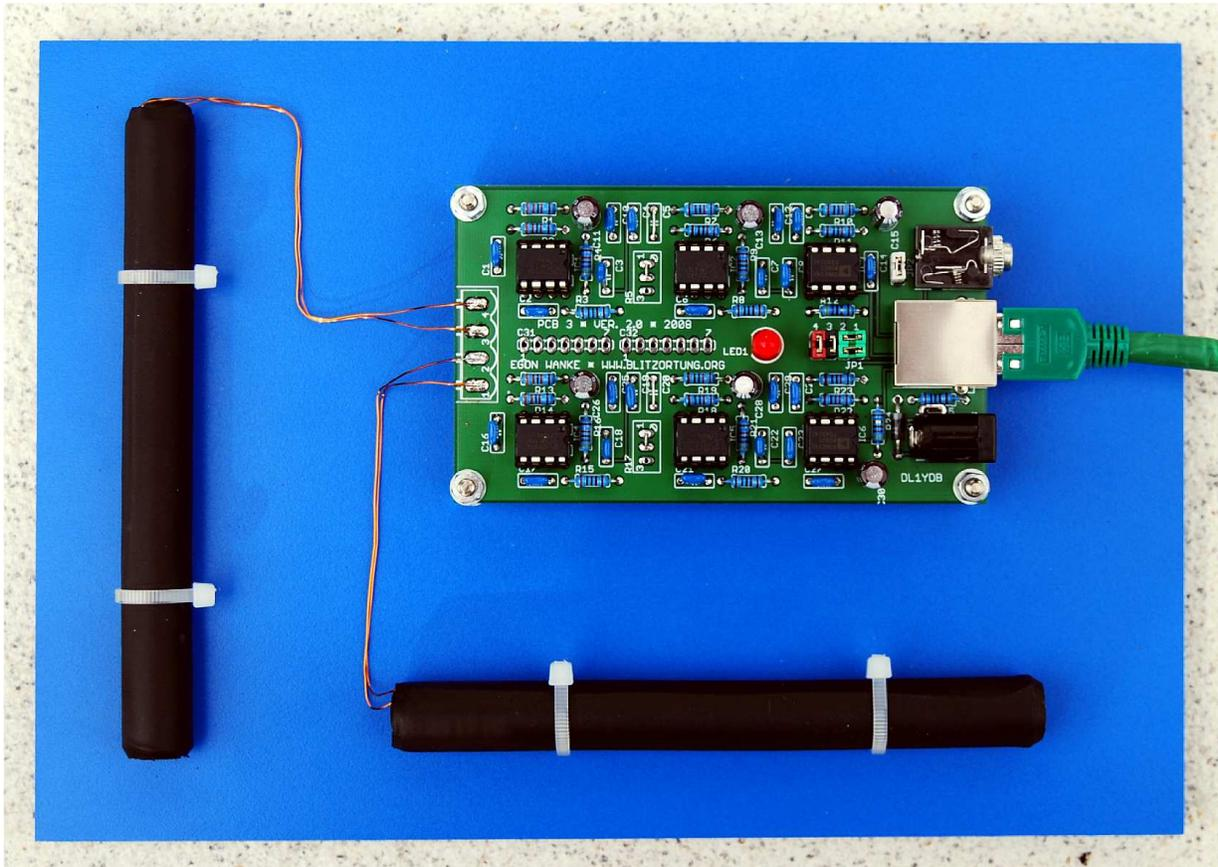

Figure 5: Two ferrite antennas mounted on a PVC board.

The size of the antenna can extremely be reduced by using ferrite rods. But a high number of turns are necessary to reach the same voltage compared with a loop antenna. This implies that the ferrite antenna has a lower resonance frequency than the loop antenna. The resonance frequency of the ferrite antenna for wide-band VLF reception should not fall below 100 kHz.

3 VLF pre-amplifier

An easy way to realize a VLF pre-amplifier is to use an operational amplifier (op-amp). The output of an op-amp is controlled either by negative feedback, which largely determines the magnitude of its output voltage gain, or by positive feedback, which facilitates regenerative gain and oscillation. Operational amplifiers have in general a high input impedance and a low output impedance.

The VLF pre-amplifier we need should use at least a first-order active low-pass filter with a cutoff frequency of approximately 15 kHz determined by

$$f = \frac{1}{2 \cdot \pi \cdot R_1 \cdot C_1},$$

see for example Figure 2. The filter reduces the signal amplitude by half (about -6 dB) every time the frequency doubles. The gain of the amplifier is determined by the voltage divider R_1/R_2 and can be computed by $1 + \frac{R_1}{R_2}$. Table 1 shows some of the possible R_1/C_1 pairs with a cutoff frequency of approximately 15 kHz and the corresponding gains with $R_2 = 1\text{k}$.

R_1	C_1	Cutoff frequency	Gain with $R_2 = 1\text{k}$
1 k	10 nF	14.5 kHz	2
2.2 k	4.7 nF	15.4 kHz	3.2
4.7 k	2.2 nF	15.4 kHz	5.7
10 k	1 nF	14.5 kHz	11
22 k	470 pF	15.4 kHz	23
47 k	220 pF	15.4 kHz	48
100 k	100 pF	14.5 kHz	101
220 k	47 pF	15.4 kHz	221

Table 1: R_1/C_1 pairs for the low-pass filter with a cutoff frequency of approximately 15 kHz.

The printed circuit board PCB 3 Version 3 realizes a two channel two stage pre-amplifier. For the sake of simplicity, the amplifier operates in single-supply mode with non-inverting attenuation, see Figure 6. The maximal gain of each stage is 48. The two stages are linked by a 50 k trimmer. The output of the second stage is optionally connected to a balanced line driver (SSM2142) to get a balanced output signal. This helps maintain the quality of the signal by eliminating power line hum, RF interference, voltage drops, and other externally generated noise commonly encountered with long cable runs. The part list of the pre-amplifier is shown in Table 2, the PCB layout is shown in Figure 7, and a complete circuit diagram is shown in Figure 10.

The DC jack can be used for power supply with positive polarization at the center. The voltage should not fall under 6 Volt and should not exceed 15 Volt. The series resistance

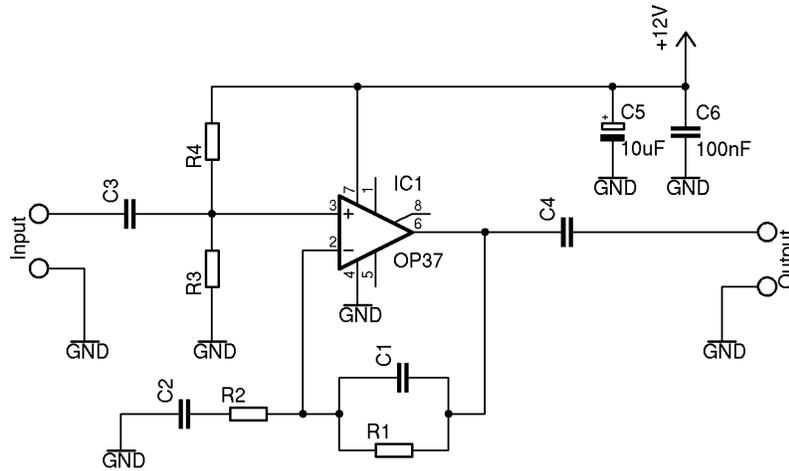

Figure 6: An amplifier stage in single-supply operation with non-inverting attenuation.

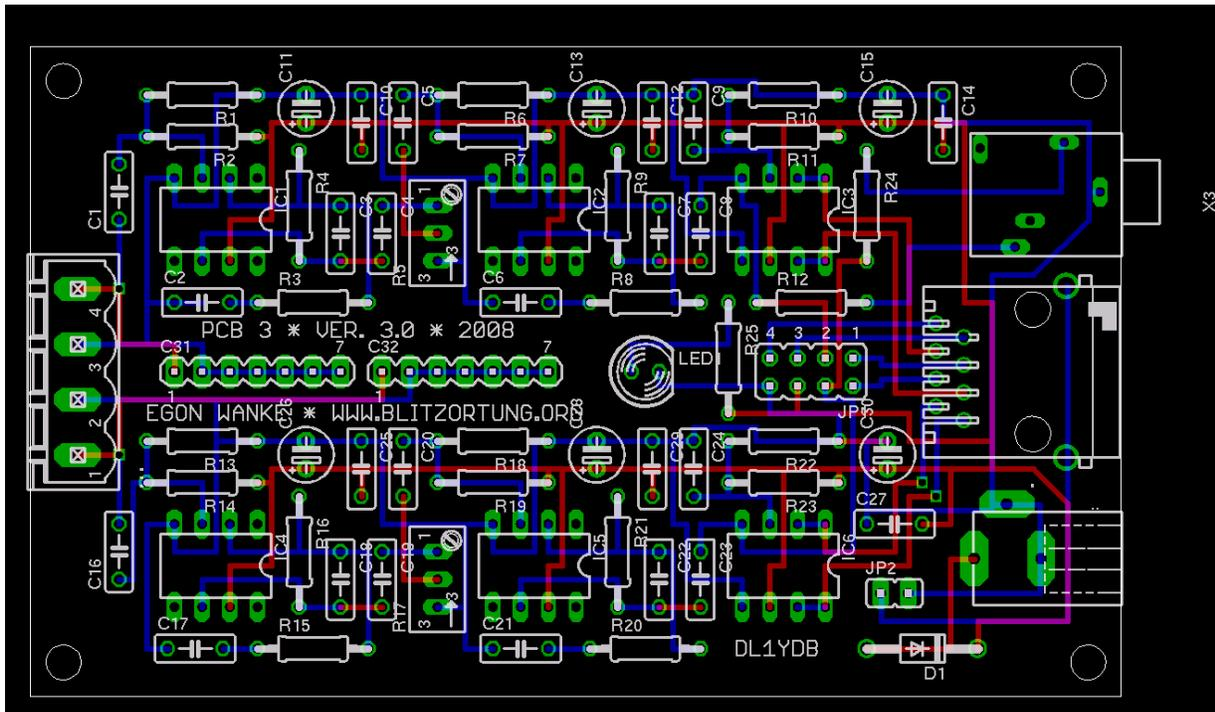

Figure 7: The layout of the VLF pre-amplifier PCB 3 Version 3.

R25 to the power control LED should be adjusted to the supplied voltage. For 12 Volt and a standard LED a series resistor of 1 k is adequate.

The 3.5 mm jack socket can be used to connect a stereo headphone. This provides an easy way to recognize interferences and thus to find a good place for an undisturbed operation. Note that the headphone has to be unplugged during normal operation.

The output voltage of the pre-amplifier should be between -2.5 Volt and $+2.5$ Volt.

Resistor, metal film	R1, R2, R13, R14	330 k 
	R4, R9, R16, R21	47 k 
	R6, R7, R10, R11, R18, R19, R22, R23	10 k 
	R3, R8, R15, R20, R25	1 k 
	R12, R24	680 Ohm 
Trimmer, 25 turn, style W	R5, R17	50 k
Capacitor, electrolytic, radial, pitch 2.5 mm	C11, C13, C15, C26, C28, C30	10 μ F
Capacitor, ceramic, pitch 5 mm	C4, C5, C8, C9, C10, C12, C14, C19, C20, C23, C24, C25, C27, C29	100 nF
	C2, C6, C17, C21	22 nF
	C1, C16	10 nF
	C3, C7, C18, C22	220 pF
Tuning Capacitor	C31, C32	not implemented
Rectifier diode	D1	1N4001
LED, standard	LED1	LED 5 mm red
Operational amplifier	IC1, IC2, IC4, IC5	OP37
Balanced line driver	IC3, IC6	SMM2142

Table 2: The part list for the VLF pre-amplifier PCB 3 Version 3.

These are the reference voltages of the analog digital converter on the evaluation board. In most cases, the board is used under the following circumstance: 12 V power supply, no balanced line driver implemented, two square loop antennas (diagonal size 1 m) with 8 turns (wire 1.5 mm²) connected to the input. In this case, you should first turn both trimmers fully up and then 8 turns down, if you are using the balanced line drivers SSM2142/SSM2141, or only 4 turns down if you are not using these balanced line drivers..

The jumpers at JP1 have the following meaning, see also Figure 9. The black and red jumper connect the power supply of the board with wire 7 and 8 of the RJ45 jack. The two green jumpers connect the single-ended (unbalanced) outputs with wire 4 and 5. The balanced outputs of the balanced line drivers are always connected to the RJ45 jack (wire 1, 2 and 3, 6). This functionality is turned off by removing the balanced line driver chips. If the power of the pre-amplifier is supplied by the evaluation board or if the power of the evaluation board is supplied by the pre-amplifier, then the red and black jumper have to be set on both boards. Note that the orientation of these jumpers is orthogonal to the

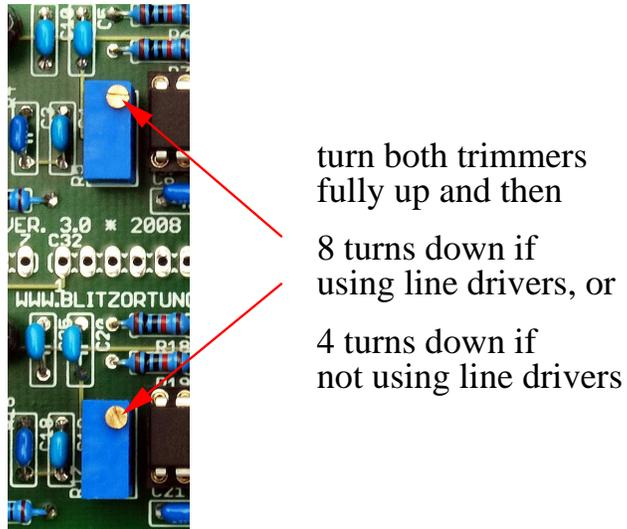

Figure 8: Trimmer adjustment.

orientation of the both green jumpers.

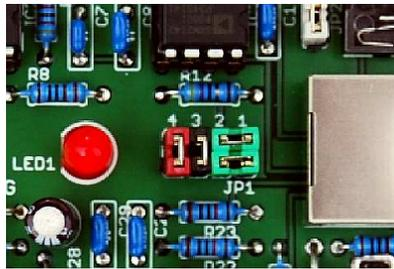

Figure 9: Jumper setting for JMP1. Remove the green jumper if you are using the balanced line drivers SSM2142/SSM2141.

Jumper JP2 connects the ground of the pre-amplifier (V_{dd} of the op-amps) with the cable shield. Setting this jumper is only necessary if the pre-amplifier is connected to a device where the cable shield is not connected to ground. In all other cases it should not be set. (In particular, it has to be removed if the pre-amplifier and the evaluation board have different power supplies.)

4 The evaluation board

The heart of the evaluation board is an Atmel 8-bit AVR micro controller ATmega644 running with a clock frequency of 20 MHz. The board also contains two 10-bit analog-to-digital converters AD7813 that operate in high speed mode not powered down between conversions. In this mode of operation the converters are capable to provide a throughput of 400 kSPS. The remaining parts are two differential amplifiers SMM2141 to receive balanced line inputs, a quad comparator LM339 to activate the analog-to-digital conversion if the input signal exceed a threshold, and a dual driver/receiver MAX232 that converts TTL input levels into RS-232 output level and vice versa.

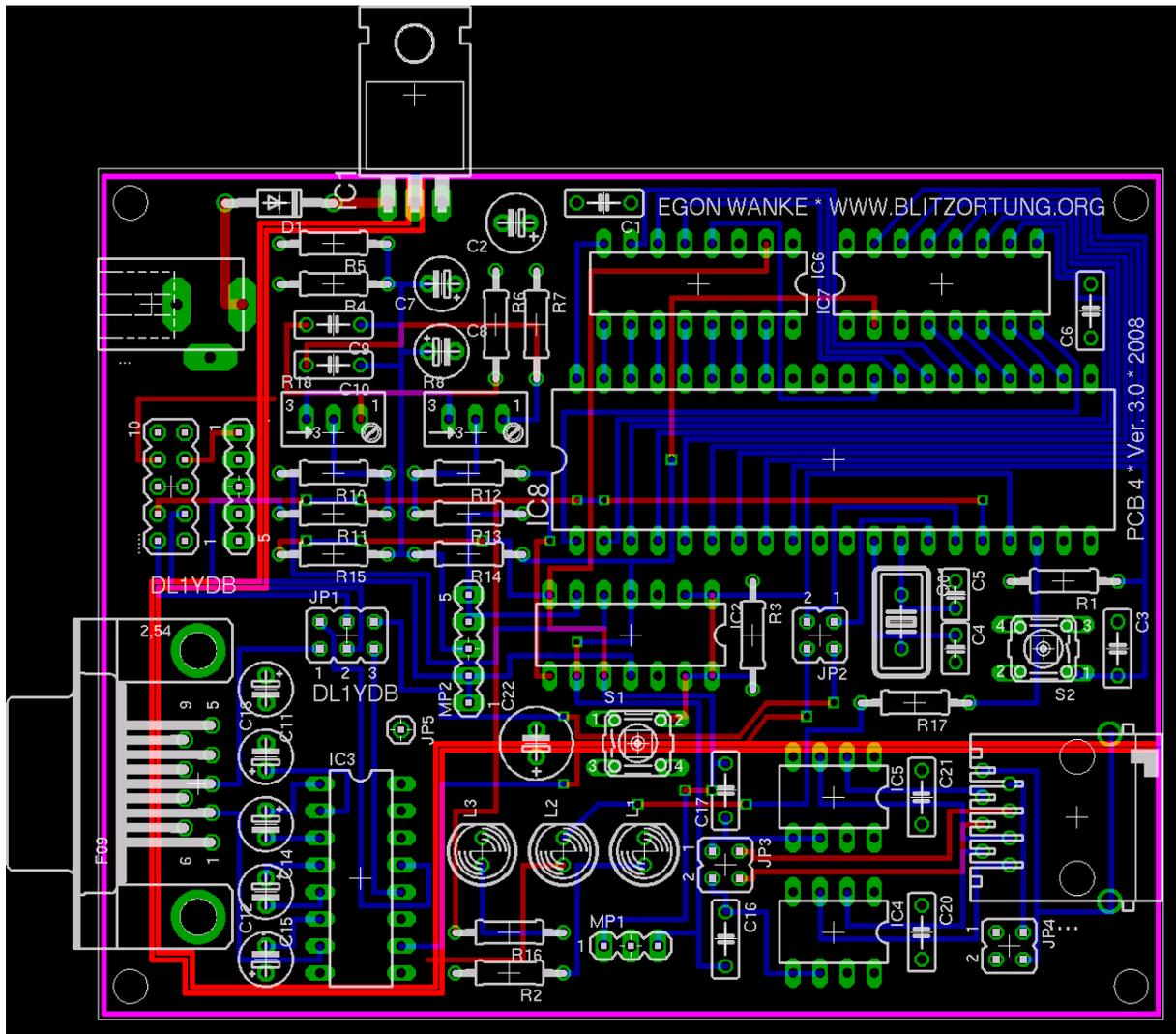

Figure 11: The layout of the evaluation board PCB 4 Version 3.

An internal timer of the controller is initiated to run with clock frequency divided by 8 and will be triggered by the rising edge of the 1PPS signal from the GPS receiver.

The counter difference between two 1PPS signals is approximately 2500000, thus one unit corresponds to 250 ns. If the signal from the receiver reaches the threshold of ± 0.5 Volt, the controller starts the analog-to-digital conversion and capture the counter at certain characteristic positions. The controller also permanently read the GPRMC data sentences of the GPS receiver to know the exact geographic position of the system.

Resistor, metal film	R1, R3, R4, R5, R6, R7, R10, R11, R12, R13, R14, R15	10 k 
	R2	1 k 
	R16, R17	330 Ohm 
Trimmer, 25 turn, style W	R8, R18	5 k
Capacitor, electrolytic, radial, pitch 2.5 mm	C22	470 μ F
	C2	100 μ F
	C7, C8, C11, C12, C13, C14, C15	4.7 μ F
Capacitor, ceramic, pitch 5 mm	C1, C3, C6, C9, C10 C16, C17, C20, C21	100 nF
	C4, C5	15 pF
Rectifier diode	D1	1N4001
LED, standard	L1	LED 5 mm red
	L2	LED 5 mm yellow
	L3	LED 5 mm green
Quartz crystal	Q1	20 MHz
Voltage regulator	IC1	78S05
Comparator	IC2	LM339
Driver/receiver	IC3	MAX232
Differential amplifier	IC4, IC5	SSM2141
Analog-to-digital converter	IC6, IC7	AD7813
Micro controller	IC8	ATmega644 20PU

Table 3: The part list for the evaluation board PCB 4 Version 3.

The pre-amplifier and the evaluation board can be connected by a 1-to-1 shielded cat cable via the RJ45 jacks. This also to use the same power supply for both boards.

As for the pre-amplifier, the DC jack can be used for power supply with positive polarization at the center. The voltage should not fall under 6 Volt and should not exceed 15 Volt. The series resistance R2 to the power control LED L1 should be adjusted to the supplied voltage. For 12 Volt and a standard LED a series resistor of 1 k is adequate. The yellow LED L2 flashes every time the controller outputs a data sentence containing strike time information. If the board is powered on, L2 is blinking 16 times. This indicates that

the controller is running. The green LED L3 is blinking every time the GPS sends a 1PPS signal.

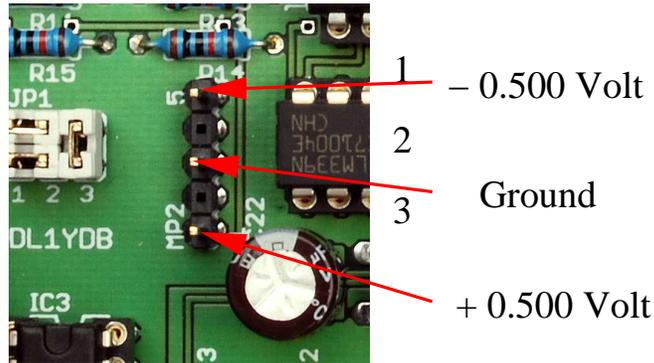

Figure 12: Threshold voltage adjustment for the comparators.

The threshold voltage for the comparators can be adjusted by the two 5 k trimmer. This header row MP1 provides at Pin 1 the negative threshold (adjusted to -0.5 Volt) and at Pin 5 the positive threshold voltage (adjusted at +0.5 Volt) with respect to the ground at Pin 3. Note that Pin 3 is not the ground of the board.

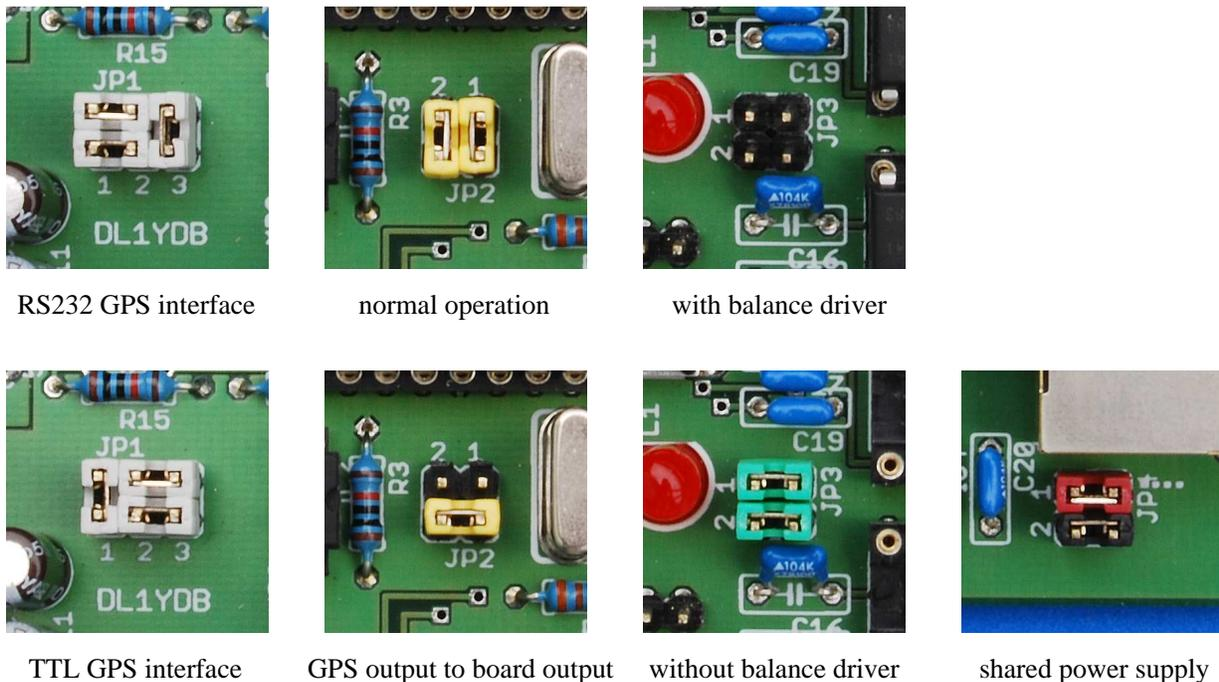

Figure 13: The jumper settings.

The jumpers have the following meanings, see Figure 13. Jumper JP1 allows to select the signal level of the serial GPS interface. Using the jumper settings in the upper (lower) figure of the GPS interface provides RS232 level (TTL level, respectively). Jumper JP2 can

be used to bypass the serial connection to/from the controller. The setting shown in the upper figure connects the output of the GPS receiver with the input of the controller and the output of the controller with the output of the board. This is the normal operation. The setting shown in the lower figure separates the controller from the serial stream. It connects the output of the GPS receiver with the output of the board. This setting allows to monitor the output of the GPS receiver at the serial RS232 interface of the board. Jumper JP3 switches the input between the single-ended signal (without using the SSM/2142/SSM2141 pairs) and the balanced signal (using the SSM2141/SSM2142 pairs). If the normal single-ended signal connection is used, jumper JP3 has to be set as shown in the lower figure, and the balanced driver chips have to be removed. The black and red jumper at JP4 connect the power supply of the board with wire 7 and 8 of the RJ45 jack. If both boards use the same power supplied, then the red and black jumper have to be set on both boards.

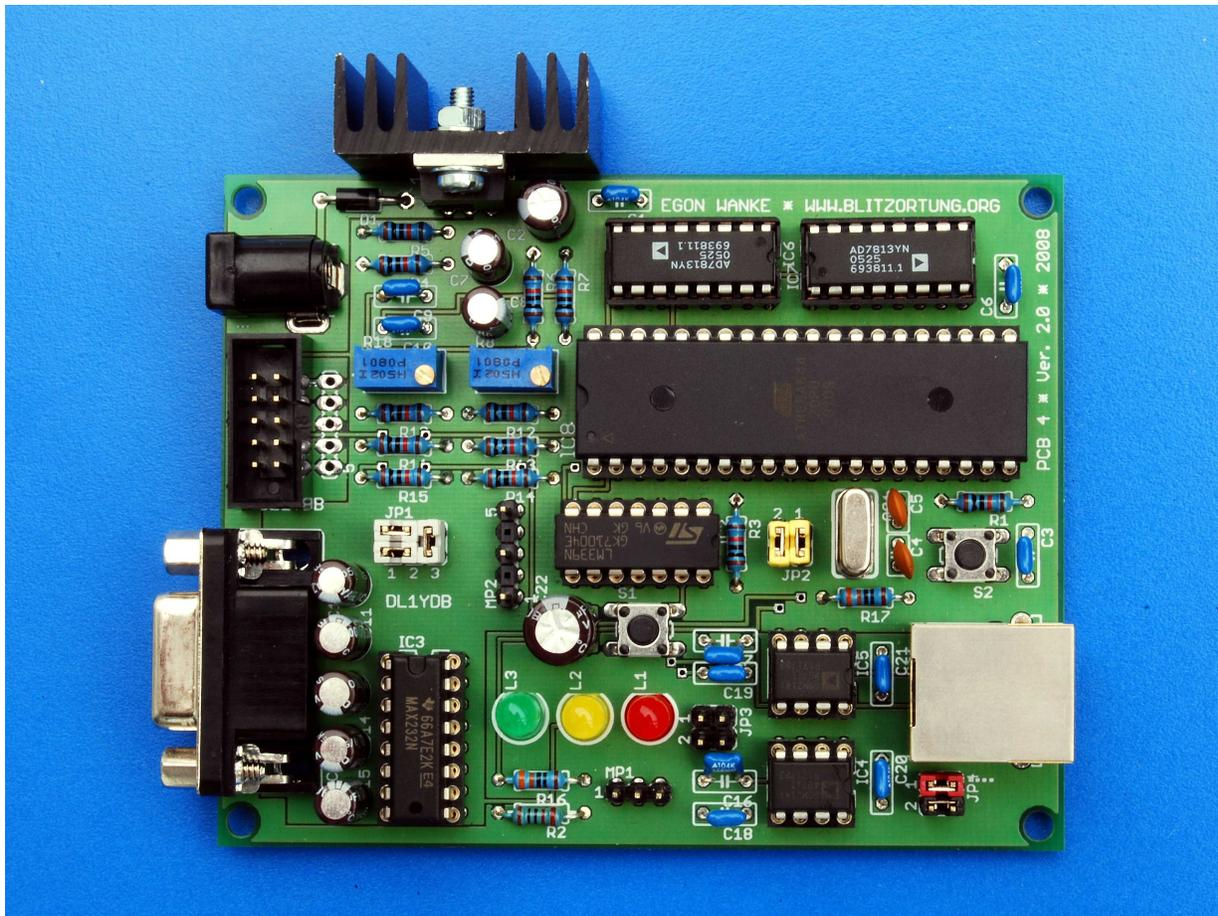

Figure 14: The assembled evaluation board PCB 4 Version 3.

The 10 way straight header wire-to-board connector is used for the GPS connection, see also Section 5 how to connect common GPS receivers to the board. The pin assignment is shown in Table 4. The power supply for the GPS receiver can be connected to Pin 10 if

it works with the same voltage as the evaluation board. It can be connected to Pin 8 if it needs only 5 Volt. Note that the voltage regulator 78S05 could extremely heat up, if the current of the GPS receiver exceeds 100 mA. Alternatively, the power supply of the GPS can be connected with Pin 7. Then the connector row beside provides all you need (V+ of the GPS receiver at Pin 1, GND at Pin 2, V+ of the board at Pin 3 to 5) to connect another separately placed voltage regulator.

Header pin	Description
1	not connected
2	serial output
3	serial input
4	1PPS input
5	GND
6	not connected
7	connected to Pin 1 beside
8	V+ after voltage regulator (+5 Volt)
9	not connected
10	V+ before voltage regulator (+12 Volt)

Table 4: Pin assignment of the connector for the GPS receiver.

The 9-way Sub-D plug is the connector for the serial RS232 interface, 4800 baud, 1 stop bit, no parity. The input to the board is directly passed to the GPS receiver. The output of the board provides data formatted NMEA 0183, Version 2.0. There are two types of sentences starting with BLSEC and BLSIG, see Table 5 and 6. A BLSEC sentence is output every second, a BLSIG sentence is output if the amplitude exceeds the threshold voltage of the comparators.

```

$BLSEC,065422,280808,A,5111.9534,N,00647.0902,E,22864F*51<CR><LF>
^      ^      ^      ^      ^      ^
|      |      |      |      |      |
|      |      |      |      |      |
|      |      |      |      |      |      Checksum
|      |      |      |      |      |
|      |      |      |      |      |      Counter, 24 bit hexadecimal
|      |      |      |      |      |
|      |      |      |      |      |      Longitude hemisphere, E or W
|      |      |      |      |      |
|      |      |      |      |      |      Longitude, 7 deg 39.3538'
|      |      |      |      |      |
|      |      |      |      |      |      Latitude hemisphere, N or S
|      |      |      |      |      |
|      |      |      |      |      |      Latitude, 51 deg 11.9531'
|      |      |      |      |      |
|      |      |      |      |      |      Status, A=active or V=Void
|      |      |      |      |      |
|      |      |      |      |      |      Date, 13.03.2008
|      |      |      |      |      |
Time, 21:29:17 UTC

```

Table 5: Format of the BLSEC sentence.

```

$BLSIG,36693D,CC0,AD4*03<CR><LF>
^      ^      ^      ^
|      |      |      |
|      |      |      |      Checksum
|      |      |      |
|      |      |      |      Amplitude channel B, 10 bit hexadecimal, last 2 bit zero, 0x800 = 0 Volt
|      |      |      |
|      |      |      |      Amplitude channel A, 10 bit hexadecimal last 2 bit zero, 0x800 = 0 Volt
|      |      |      |
Counter, 24 bit hexadecimal

```

Table 6: Format of the BLSIG sentence.

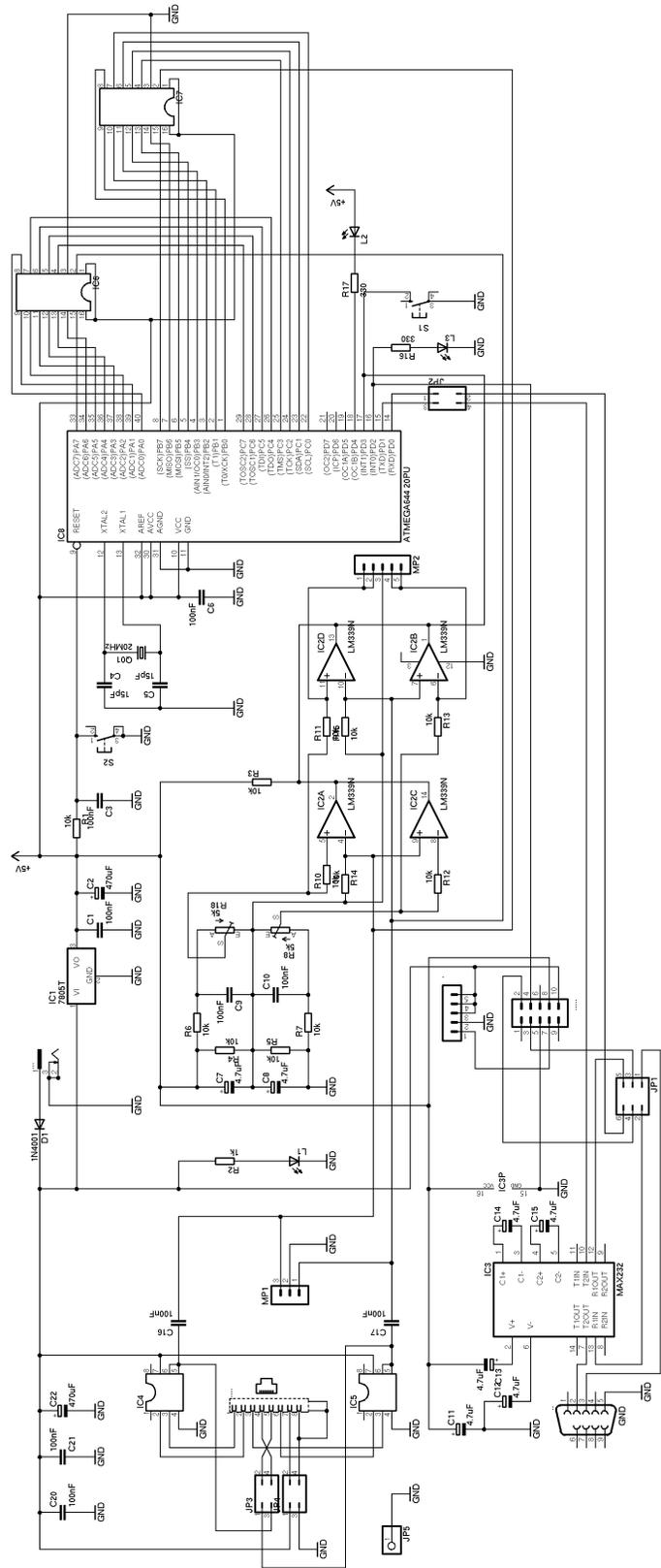

Figure 15: The circuit diagram of the evaluation board PCB 4 Version 3.



Garmin 35



AQTIME VP-200T



Fortuna U2

Figure 16: Some GPS receivers providing a 1PPS output.

evaluation board. It comes with 5 meters of cable ending stripped and pre-tinned assembled for a flexible connection. The wires we need for the connection to the evaluation board have the following colors and have to be connected to the following pins of the straight header at the evaluation board.

Color	Description	Header
white	serial input RS232	2
blue	serial output RS232	3
grey	1PPS output	4
black	power ground	5
red	+12 Volt	10

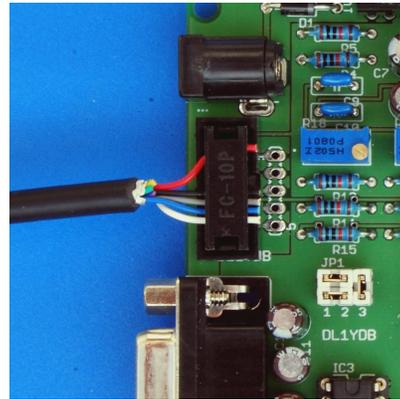

In 1PPS is not output by default. This feature has first to be set up by an initialization. Our tracker program initializes the GPS receiver by sending the following strings.

```
$PGRMO,GPGGA,0*00<cr><lf>
$PGRMO,GPGSA,0*00<cr><lf>
$PGRMO,GPGSV,0*00<cr><lf>
$PGRMO,GPRMC,1*00<cr><lf>
$PGRMO,GPVTG,0*00<cr><lf>
$PGRMO,PGRMT,0*00<cr><lf>
$PGRMC,,,,,,,,,3,,2,4,*00<cr><lf>
```

This initialization turns off the data sentences GPGGA, GPGSA, GPGSV, GPVTG, and PGRMT, turns on the GPRMC sentence for an output by every second, set the Baud

rate to 4800 Baud, and activates the 1PPS output with a duration of 100 ms. The Baud rate and PPS mode changes take effect on the next power on cycle.

The **Garmin 35-LVS** differs from the Garmin 35-HVS only in the voltage of the power supply. The LVS version is designed to operated from a voltage of 3.6 Volt to 6 Volt. Its power consumption is approximately 150 mV. Here we recommend to use a separate voltage regulator, or a separate power supply. Both can easily be connected to the board if the red wire of the GPS cable is connected to Pin 7 of the straight header. Then the connection row beside the straight header provides the power supply of the GPS receiver at Pin 1, the ground at Pin 2, and the +12 Volt power supply of the board at Pin 3. Some versions of the Garmin 35-LVS have a jack with built-in DC/DC converter which provides +5 Volt output for the GPS receiver. Unfortunately, we have to cut off the jack to get the 1PPS wire, but DC/DC converter can be used with the 12 Volt power supply of the board.

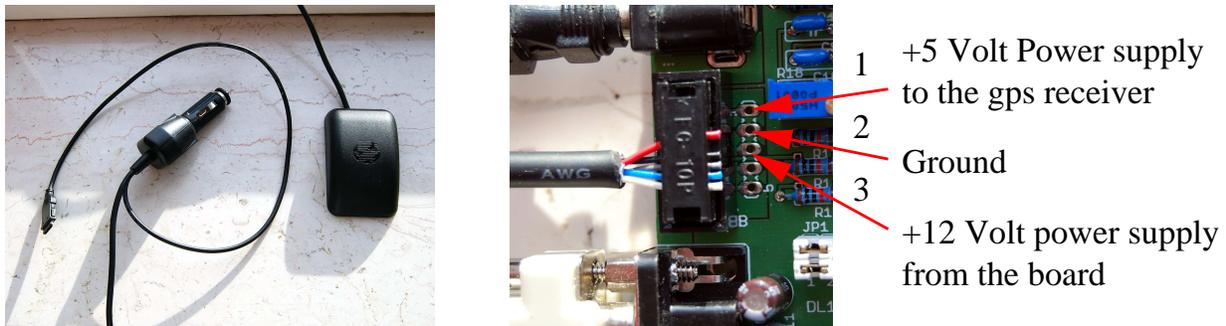
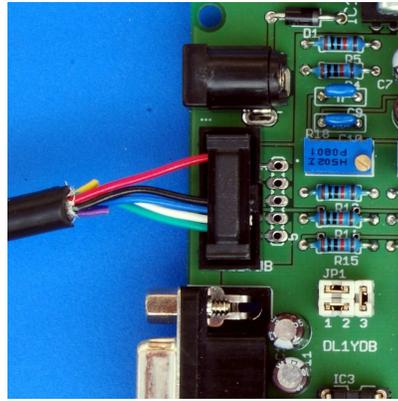

Figure 17: Garmin 35-LVS with power supply at Pin 7.

Note that the two Garmin 35 GPS receivers produce some low acoustic noises which seems to be not worryingly.

The **AQTIME VP-200T** is a timing GPS receiver and antenna in a compact/weather-proof enclosure for time-measuring application. It outputs a 1PPS pulse with $\pm 100ns$ tolerance. It has also a flexible power supply of 8 Volt to 40 Volt. The power consumption is typically 1.1 W. The receiver can also easily be supplied by the 12 Volt power supply of the evaluation board. It comes with 5 meters of cable ending with a 9-ways SUB-D plug for the serial interface, a DC plug for power supply, and a phono plug for the 1PPS signal. The wires we need for the connection to the evaluation board have the following colors (if the plugs are cut off) and can be connected to the following pins of the straight header.

Color	Description	Header
green	serial input RS232	2
white	serial output RS232	3
blue	1PPS output	4
black	power ground	5
red	+12 Volt	10



The AQTIME VP-200T provides the 1PPS signal with a duration of 100 ms by default. The initialization by the tracker program switches off the data sentences GPGGA, GPGLL, GPGSA, GPGSV, GPDTM, and PGZDA. The data sentence GPRMC is switched on for an output of every second.

```
$PFEC,GPint,GGA00,GLL00,GSA00,GSV00,RMC01,DTM00,VTG00,ZDA00*00<cr><lf>
```

The communication speed of the serial interface is 4800 Baud by default and can not be changed.

The **Fortuna U2-PS/2** is a small GPS mouse using a SiRF starII chipset. The body is not completely water resistant, and thus not adequate for outdoor mounting. It comes with 2 meters of cable ending in a 6-ways Mini-DIN plug. Although the GPS module provides the 1PPS output with a duration of 100 ms, the signal is not connected to the cable. This can be changed by a simple modification. Note that there are several versions of the Fortuna U2. Some of them provide an USB interface (Fortuna U2-USB). These receivers can not be used in connection with the evaluation board. Newer versions use a SiRF III chipset. We do not know whether the SiRF III module also provide the 1PPS output. If somebody has find out this, please give us some feed back. Then we will include this information here.

To modify the Fortuna U2-PS/2 you have to open die housing by taking out the two screws on the backside. Then you can remove the cap and will find a soldered copper box, see Figure 18 to the left. The cap contains two slices that makes the base of the receiver magnetic, see Figure 18 to the right. These two slices usually fall down when opening the housing. If you open the copper box you will find the GPS module. You have to move the yellow wire from Pin 2 to Pin 9, see Figure 18 in the middle. After that you can solder up the copper box. An easy way to mount the cap with the two magnetic slices is the following. Attach the cap on a metal board by the magnetic slices from inside. Then insert the module and push the housing to the cap. After the modification the 6-way female Mini-DIN plug has the following pin assignment. Note that the information about the pin assignment at the folder enclosed to the original package of the Fortuna U2-PS/2 is wrong!

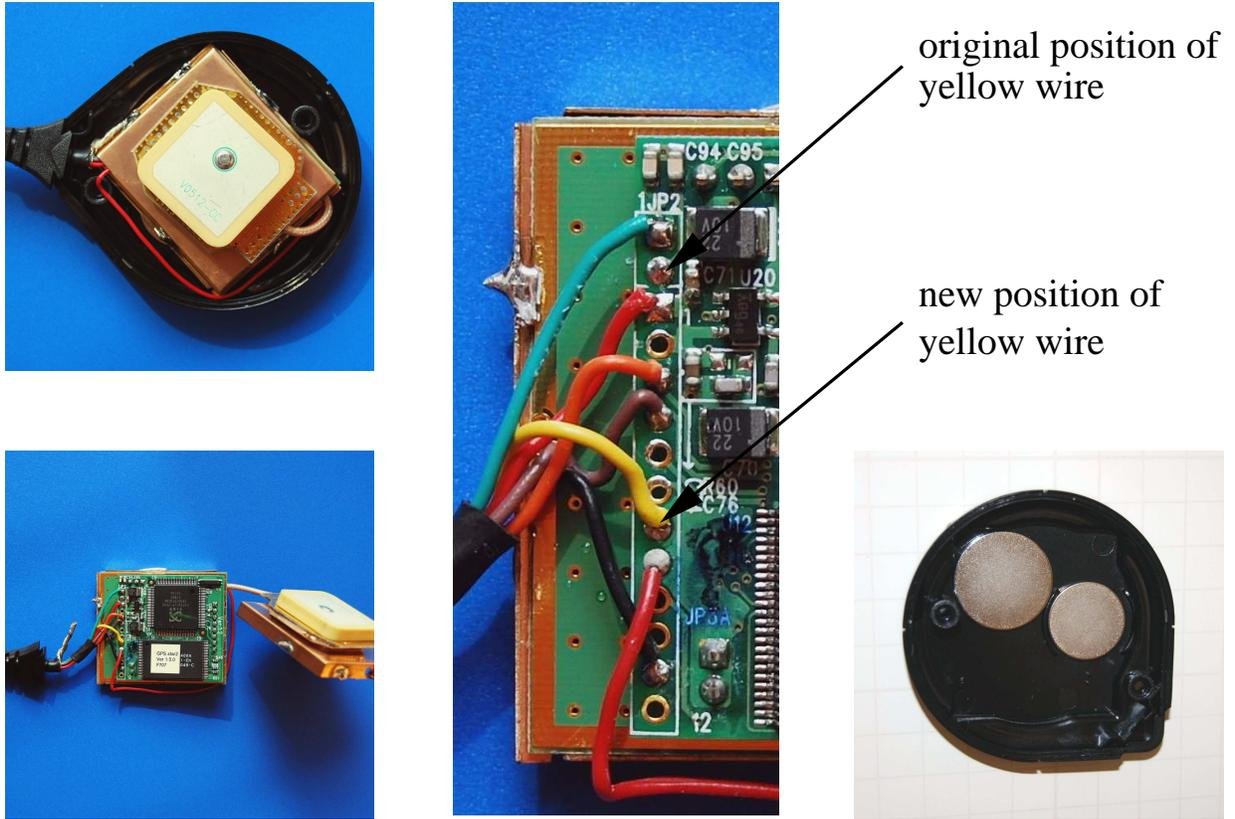
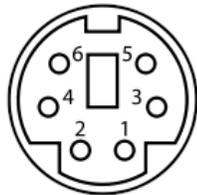

Figure 18: The modification of the Fortuna U2.

Color	Meaning	Mini-DIN	Header
orange	serial input RS232	4	2
brown	serial output RS232	2	3
yellow	1PPS output	1	4
black	ground	3	5
red	+5 Volt	6	8
green	unknown	5	-



Female 6-ways Mini-DIN connector from the front

The initialization by the tracker program switches off the data sentences GPGGA, GPGLL, GPGSA, GPGSV, GPMSS, GPDTM, and PGZDA. The data sentence GPRMC will be switched on for an output by every second.

```
$PSRF103,00,00,00,01*00<cr><lf>
```

```
$PSRF103,01,00,00,01*00<cr><lf>
$PSRF103,02,00,00,01*00<cr><lf>
$PSRF103,03,00,00,01*00<cr><lf>
$PSRF103,04,00,01,01*00<cr><lf>
$PSRF103,05,00,00,01*00<cr><lf>
$PSRF103,06,00,00,01*00<cr><lf>
$PSRF103,08,00,00,01*00<cr><lf>
```

The communication speed of the serial interface is 4800 Baud by default. The power supply is 5 Volt, the power consumption is approximately 90 mV. If the receiver should be supplied by the +5 Volt power supply after the voltage regulator of the evaluation board, then the +5 Volt power supply wire can be connected to Pin 8 of the header connector. If the temperature of the voltage regulator exceeds 40 degree, it should be mounted on a larger cooling device, or the GPS receiver should be supplied by a separate voltage regulator or power supply, respectively.



Figure 19: Different connections of the Fortuna U2-PS/2 to the evaluation board.

You can either cut of the Mini-DIN connector from the cable and connect the wires directly to the jack or, if you do not like this destructive solution, you can use an extension cable. In Figure 19 to the left, the receiver cable is directly connected to the board. The two Figures to the right show a connection with an additional extension cable. Both connections use the +5 Volt power of the board to supply the GPS receiver.

There are several further GPS receivers that can be connected to the board. For example, the Garmin 16-HVS can be handled in the same way as the Garmin 35-HVS. The GM-44 has to be modified similarly as the Fortuna U2.

6 Data upload

The data upload to our computing server is done by a tracker program. There are two versions of tracker programs, one for computers running Linux operating system and one for computers running Windows operating system. The tracker program for Linux is written by Egon Wanke and will be send to you on request. The tracker program for Windows is written by Edmund Korffmann and can be downloaded from riedwetter.myvnc.com.

To upload data with the tracker program you have to insert your username and password in the "Password" menu. The "Interval" menu allows you to set the time span the tracker will try to establish a connection to our server. It should be set to 20 seconds. Activating the "Auto" flag will cause the tracker to start up automatically after the PC will restart. If the "Minimize" flag is set the tracker window will disappear from the desktop. The "Log" flag activates log file output, and the "Adj. System Time" option allows to synchronize the local clock by the GPS time.

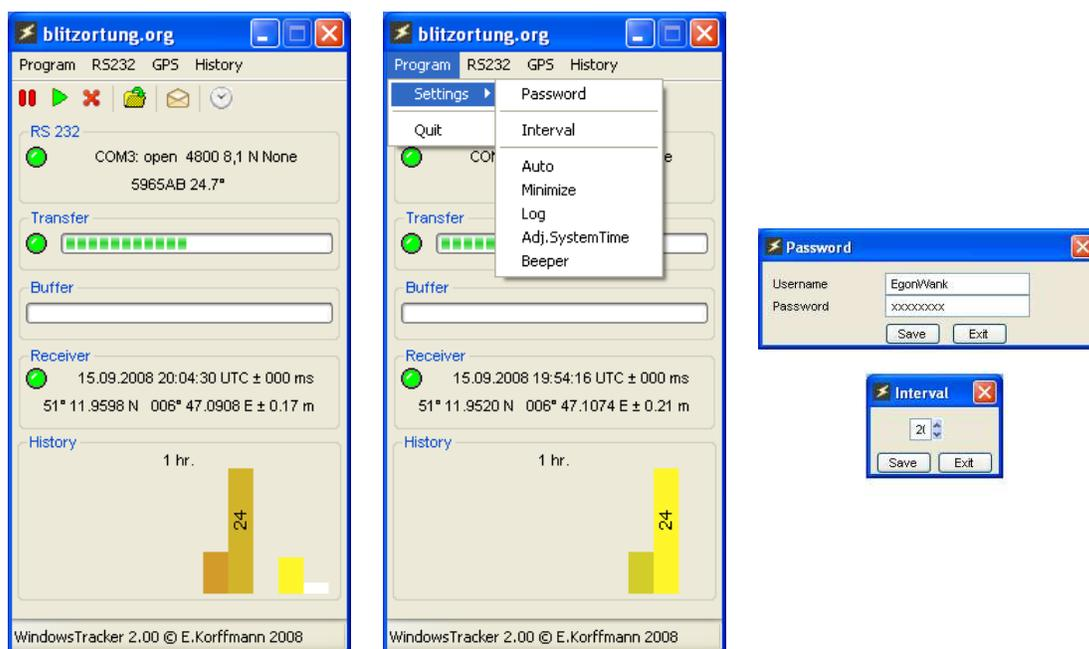

Figure 20: Some screen dumps of the tracker program for Windows.

The serial interface of the evaluation board works with 4800 Baud, 1 stop bit, no parity. The GPS menu can be used to initialize the GPS device. If you need an additional initialization strings for your special GPS device, please contact us. The "History" menu allows to change the scaling for the strike number visualization. Here the complete time span and the number of bars can be specified. The height of a bar corresponds to the number of strikes in the corresponding time interval.

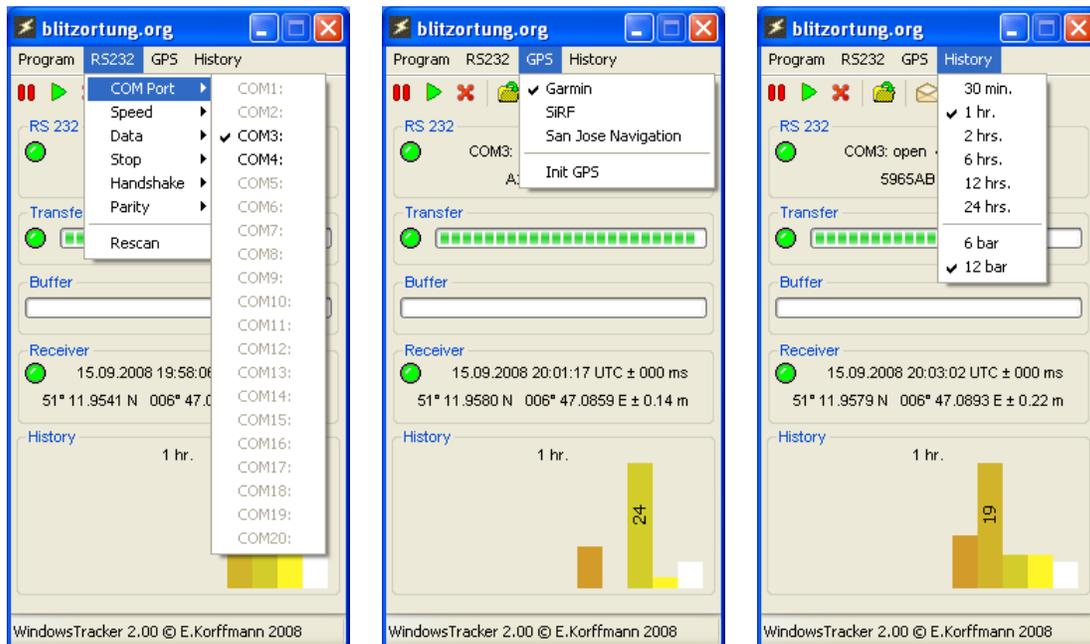

Figure 21: Some screen dumps of the tracker program for Windows.

7 Prices and how to get the material

We only offer the PCBs and the programmed micro controller. We do not offer completely assembled kits. You have to gather all the additional necessary material by yourself. In exceptional cases we deliver the analog-to-digital converters AD7813 and balanced line driver pairs SSM2141/SSM2124 if they are difficult to get in certain countries. Note also, that the driver pairs SSM2141/SSM2124 are not essentially.

To get an overview of the costs for assembling such a system, we state here some prices of the used parts. These are prices of traders in Germany. Clearly, the prices will differ from country to country, but a rough orientation seems to be always interesting. All prices stated at Table 8 and 9 were valid at the time the document was written and include 19% of german purchase tax. The order code can be used to find the article at the vendors online shop. This sometimes give you additional interesting information about the parts. We do not have any contracts with these vendors, feel free to buy everywhere you want.

The PCBs, the micro controller, the analog-to-digital converters, and the balanced line driver pairs SSM2141/SSM2124 can be ordered by the author of this document. You will receive bank account information on request.

Part	Price	Trader	Order Code
Semiconductors			
4 × OP37	4 × 1,56 €	www.Reichelt.de	OP 37 GP
2 × SSM2142	2 × 6,50 €	by the author	1079398
1 × 1N4001	1 × 0,02 €	www.CSD-Electronics.de	11001
1 × LED, 5 mm	1 × 0,05 €	www.CSD-Electronics.de	25-5110019
Σ	19,31 €		
Capacities			
6 × 10μF, 100 V, electrolytic, pitch 2.5 mm	6 × 0,05 €	www.CSD-Electronics.de	120-R0010V100
14 × 100 nF, ceramic, pitch 5 mm	14 × 0,06 €	www.CSD-Electronics.de	11407
4 × 22 nF, ceramic, pitch 5 mm	4 × 0,05 €	www.CSD-Electronics.de	11387
2 × 10 nF, ceramic, pitch 5 mm	2 × 0,05 €	www.CSD-Electronics.de	11385
4 × 220 pF, ceramic, pitch 5 mm	4 × 0,04 €	www.CSD-Electronics.de	11370
Σ	1,60 €		
Resistors			
4 × 330k, metal film	4 × 0,08 €	www.CSD-Electronics.de	11-K330
2 × 50k, 25 turn, trimmer, type W	2 × 0,55 €	www.Reichelt.de	64W-50k
8 × 10k, metal film	8 × 0,08 €	www.CSD-Electronics.de	11-K010
4 × 47k, metal film	4 × 0,08 €	www.CSD-Electronics.de	11-K047
5 × 1k, metal film	5 × 0,08 €	www.CSD-Electronics.de	11-K001
2 × 680, metal film	2 × 0,08 €	www.CSD-Electronics.de	113-0680
Σ	2,94 €		
Further material			
1 × PCB 3, Version 3	1 × 15,00 €	by the author	
1 × RJ45 jack, 8 ways, shielded	1 × 0,55 €	www.CSD-Electronics.de	015-5402
1 × DC jack, PCB, 2.1 mm	1 × 0,19 €	www.CSD-Electronics.de	015-5604
1 × DC jack, PCB, 2.5 mm	1 × 0,18 €	www.CSD-Electronics.de	015-5602
1 × Pin header, 40 pins	1 × 0,18 €	www.CSD-Electronics.de	015435
1 × Jumper black	1 × 0,04 €	www.CSD-Electronics.de	015490
1 × Jumper red	1 × 0,04 €	www.CSD-Electronics.de	015491
2 × Jumper green	2 × 0,06 €	www.CSD-Electronics.de	015495
1 × Jumper gray	1 × 0,06 €	www.CSD-Electronics.de	015494
1 × Jack socket, PCB, 3,5 mm	1 × 0,20 €	www.CSD-Electronics.de	015-BU351SP
2 × Terminal block, PCB, 2 way, 5.08 mm	2 × 0,12 €	www.CSD-Electronics.de	015901
6 × IC socket, 8 ways	6 × 0,10 €	www.CSD-Electronics.de	15-DIP08PZ
Σ	17,40 €		
Σ	<u>41,25 €</u>		

Table 8: Prices of the parts for the pre-amplifier.

Part	Price	Trader	Order Code
Semiconductors			
1× ATmega644-20PU	1 × 5,95 €	by the author	
2× AD7813	2 × 7,85 €	by the author	
2× SSM2141	2 × 4,50 €	by the author	
1× LM339	1 × 0,10 €	www.Reichelt.de	LM 339 DIL
1× MAX232	1 × 0,32 €	www.Reichelt.de	MAX 232 CPE
1× 78S05	1 × 0,32 €	www.CSD-Electronics.de	22-0520
1× 1N4001	1 × 0,02 €	www.CSD-Electronics.de	11001
1× LED, 5 mm, red	1 × 0,05 €	www.CSD-Electronics.de	25-5110019
1× LED, 5 mm, yellow	1 × 0,05 €	www.CSD-Electronics.de	25-5130040
1× LED, 5 mm, green	1 × 0,05 €	www.CSD-Electronics.de	25-5120019
Σ	31,56 €		
Capacities			
1 × 470μF, 16 V, electrolytic, pitch 2.5 mm	1 × 0,07 €	www.CSD-Electronics.de	120-R0100V035
1 × 100μF, 25 V, electrolytic, pitch 2.5 mm	1 × 0,07 €	www.CSD-Electronics.de	120-R0100V035
7 × 4.7μF, 100 V, electrolytic, pitch 2.5 mm	7 × 0,04 €	www.CSD-Electronics.de	120-R0005V100
9 × 100 nF, ceramic, pitch 5 mm	9 × 0,06 €	www.CSD-Electronics.de	11407
2 × 15 pF, ceramic, pitch 5 mm	2 × 0,04 €	www.CSD-Electronics.de	11359
Σ	1,04 €		
Resistors			
12 × 10k, metal film	12 × 0,08 €	www.CSD-Electronics.de	11-K010
2 × 5k, 25 turn, trimmer, type W	2 × 0,55 €	www.Reichelt.de	64W-5,0K
1 × 1k, metal film	1 × 0,08 €	www.CSD-Electronics.de	11-K001
2 × 330, metal film	2 × 0,08 €	www.CSD-Electronics.de	113-0330
Σ	2,30 €		
Further material			
1× PCB 4, Version 3	1 × 15,00 €	by the author	
1× Crystal, 20 MHz	1 × 0,16 €	www.CSD-Electronics.de	14-U20,000MHZ
1× RJ45 jack, 8 ways, shielded	1 × 0,55 €	www.CSD-Electronics.de	015-5402
1× DC jack, PCB, 2.1 mm	1 × 0,19 €	www.CSD-Electronics.de	015-5604
1× DC jack, PCB, 2.5 mm	1 × 0,18 €	www.CSD-Electronics.de	015-5602
1× Straight Header Connector jack, 10 ways	1 × 0,08 €	www.CSD-Electronics.de	015-WG10
2× Header Connector plug, 10 ways	2 × 0,10 €	www.CSD-Electronics.de	015-PF10
1× Pin header, 40 pins	1 × 0,18 €	www.CSD-Electronics.de	015435
1× Jumper black	1 × 0,04 €	www.CSD-Electronics.de	015490
1× Jumper red	1 × 0,04 €	www.CSD-Electronics.de	015491
3× Jumper gray	3 × 0,06 €	www.CSD-Electronics.de	015494
2× Jumper yellow	2 × 0,06 €	www.CSD-Electronics.de	015496
2× Jumper green	2 × 0,06 €	www.CSD-Electronics.de	015495
2× Mini switch	2 × 0,11 €	www.CSD-Electronics.de	35101
1× Sub-D plug, PCB, 9 ways	1 × 0,21 €	www.CSD-Electronics.de	5200
1× Cooling device, TO220	1 × 1,20 €	www.CSD-Electronics.de	018-SK7525SA220
1× IC socket, 40 ways	1 × 0,43 €	www.CSD-Electronics.de	15-DIP40PZ
3× IC socket, 16 ways	3 × 0,19 €	www.CSD-Electronics.de	15-DIP16PZ
1× IC socket, 14 ways	1 × 0,17 €	www.CSD-Electronics.de	15-DIP14PZ
2× IC socket, 8 ways	2 × 0,10 €	www.CSD-Electronics.de	15-DIP08PZ
Σ	20,04 €		
Σ	54,94 €		

Table 9: Prices of the parts for the evaluation board.